



Sports Development Group / Groupe de Développement Sportif

2024 ASN Canada AUTOSLALOM REGULATIONS

Appendix C - Roll Over Bars

Appendix D - Roll Cages

Published by:

GDS - ASN Canada,

200 circuit Gilles-Villeneuve, Montreal, Quebec, H3C 1A9

Telephone: (514) 350-8203 Email: info@asnCanada.ca

**ASN CANADA IS THE GOVERNING BODY OF MOTORSPORT IN CANADA
APPOINTED BY THE FEDERATION INTERNATIONALE DE L'AUTOMOBILE**

These regulations are intended to assist in the conduct of events and to further general safety.

They are a guide, and in no way a guarantee against injury or death to participants, spectators or others.

Canadian territories and regions may adopt these regulations for use within their jurisdictions if they choose to do so including the sole responsibility for the administration thereof.

No express or implied warranties of safety or fitness for a particular purpose shall be intended or result from publication of or compliance with these Regulations.

The contents of this document are copyright may be reproduced only with permission in writing from GDS ASN Canada

Note: Regulations that are changed from the previous edition are indicated by a *red, bold, italics font.*



Table of Contents

Appendix C - Roll Over Bars Specifications	3
1. GENERAL.....	3
2. CONSTRUCTION MATERIALS.....	3
3. FABRICATION	3
4. BRACING.....	4
5. REMOVABLE BRACING.....	4
6. MOUNTING PLATES	4
7. WELDING.....	5
8. ALTERNATE DESIGNS.....	5
APPENDIX D – ROLL CAGE SPECIFICATIONS	6
1. GENERAL REQUIREMENTS.....	6
2. CONSTRUCTION MATERIALS.....	6
3. FABRICATION	7
4. BRACING.....	8
5. MOUNTING PLATES	8
6. WELDING.....	8
7. GUSSETING	9
8. REMOVABLE TYPE CAGES	9
9. ALTERNATE DESIGNS.....	9

Appendix C - Roll Over Bars Specifications

1. GENERAL

Where permitted or specified by the regulations of a series or event, roll bars meeting these specifications shall be fitted to all cars.

It is highly recommended that roll cages meeting the specifications outlined herein be fitted to all cars competing in events where rollover protection is required.

The top of the roll bar shall be at least 5.08 cm (2") above the top of the competitor helmet or as close to the roof as possible.

The top of the roll bar shall be no more than 25.4 cm (10") behind the competitor's helmet when the competitor is seated in the normal driving position.

It is highly recommended that any part of the roll bar or of the car's structure which may be struck by the competitor's helmet in an impact be covered with a flame-retardant energy absorbing material. Padding meeting SFI spec 45.1 is highly recommended.

2. CONSTRUCTION MATERIALS

The main hoop and primary bracing should be constructed from round, mild steel, ERW or DOM type tubing.

Chrome-moly tubing such as 4130, may be used but is not recommended.

Chrome moly welding most often requires pre-heating, compatible filler wire to avoid brittleness in the welds, post-weld cooling and stress-relieving.

Aluminum and composite materials are prohibited construction materials for roll bar structures.

All bars must have a 0.476 cm (.1875") diameter inspection hole drilled in each main hoop.

Minimum tubing sizes are as follows with vehicle weights including competitor:

Up to 2,000 lbs. 3.81 cm X 0.30 cm (1.50" X .120")

Over 2,000 lbs. 4.44 cm X 0.30 cm (1.75" X .120")

3. FABRICATION

One continuous piece of tubing must be used for the main hoop. All bends must be smooth with no evidence of crimping or wall fracturing.

All bars should start as close as possible to the floor of the vehicle and come as close as possible to the sides of the vehicle for maximum competitor protection.

In the case of tube frame vehicles, the roll cage structure must be attached to the chassis with suitable webbing or gusseting to distribute loads over as wide an area as possible.

In the case of unit body vehicles, it is recommended procedure to attach the ends of the main hoop tubes into L shaped plates at the junction of the floor and rocker panels rather than just to a plate on the floor. Additionally, it is highly recommended that all bars be tabbed into the basic body structure at least every 60.96 cm (24") or wherever possible.

Gussets or tie-in tubes must be used at main tube junctions of the roll bar members. Gusset thickness should be a minimum of the tubing wall thickness to which they are attached.

4. BRACING

Rear stays must attach to the hoop no lower than 20.32 cm (8") from the top of the hoop and at an angle no steeper than 35 degrees from vertical.

These rear stays must be made from a straight piece of tubing and be attached to a suitably stiff or reinforced area. In cases where rearward braces are impractical, forward braces are permitted.

In order to minimize the distortion of the roll bar in the event of impact on one corner, a diagonal brace is required. This brace must be a straight as possible.

Where a "six point roll bar" is used, front stays must attach to the hoop no lower than 20.32 cm (8") from the top of the hoop and at an angle no steeper than 35 degrees from vertical.

These front stays must be made from a straight piece of tubing and be attached to a suitably stiff or reinforced area.

Where a "five point roll bar" is used, a single front stay must attach to the hoop on the driver's side of the vehicle centerline at an angle no steeper than 35 degrees from the vertical.

This brace must be made from a straight piece of tubing, extend forward to the diagonally opposite side of the car and be attached to a suitably stiff or reinforced area.

5. REMOVABLE BRACING

Removable bracing may be fitted to vehicles only if their construction and design allow them to meet the strength requirements of the designs above.

Where tubes join, a double shear type mating tab may be used.

Where such a tab is used, the tube joining this tab shall have a small piece of tubing welded perpendicular to its length for the bolt to pass through to prevent crushing of the main tube.

Tabs shall be at least 3.49 cm (1.375") wide and 0.476 cm (.1875") thick and must be welded to one of the main tubes.

When single bolts are used to fasten tubes, they must be of at least 1.11 cm (.4375") diameter and grade 8 material.

Sliding tube type junctions may also be used if they meet the following criteria:

- Wall thickness of the joining tube shall be a minimum of 0.30 cm (.120").
- Length of this tube shall be a minimum of 7.62 cm (3") on either side of the splice.

Attachment shall be made using two bolts on each side of the splice 90 degrees to each other passing straight through the tubing.

Grade 5 or better bolts of at least 9.52 cm (.375") diameter shall be used here.

Splicing tubes may be slid either inside the main tubing or over the outside.

Basic design and fabrication of removable braces must conform to the specifications for non-removable designs.

6. MOUNTING PLATES

The lower hoop tubes must be connected to plates welded or bolted to the frame or floor of the vehicle.

On unit body vehicles, all plates shall be at least 129 square cm (20 square") in area.

The minimum thickness of these plates shall be 0.20 cm (.080") in the case of weld on plates and .1875 for bolt on types.

Bolt on types shall have a minimum of three 0.952 cm (.375") grade 5 bolts or better fastening each plate and must have a backup plate of equal size and thickness on the other side of the floor with the bolts passing through both plates and the floor.

Vehicles with frame type construction must use plates of at least 51.6 square cm (8" square) area and .1875 thickness regardless of whether they are bolted or welded.

7. WELDING

It is essential that all welding be of the highest possible quality.

Slag welds, poor arc and gas welds are NOT acceptable.

It is highly recommended that only certified welders carry out welding on roll bars.

TIG or MIG are the preferred welding processes.

Structures with unacceptable welding will not be approved.

8. ALTERNATE DESIGNS

Alternate cage designs may be allowed by the Chief Scrutineer provided the competitor can produce stress analysis data from a certified engineer stating that the roll over structure is capable of withstanding the following loads applied simultaneously to that structure:

1.5 G lateral

5.5 G fore/aft

7.5 G vertical

Calculations shall assume race-ready weight of the vehicle with competitor on board.

APPENDIX D – ROLL CAGE SPECIFICATIONS

1. GENERAL REQUIREMENTS

Where this section applies to vehicles, a roll cage conforming to the following specifications is required:

The top of the roll bar shall be at least 5.08 cm (2") above the top of the competitor helmet or as close to the roof as possible.

The top of the roll bar shall be no more than 25.4 cm (10") behind the competitor's helmet when the competitor is in the normal driving position.

It is highly recommended that any part of the roll cage structure which may be struck by the competitor's helmet in a serious impact be covered with a flame-retardant energy absorbing material.

Vintage racing vehicles built and raced before January 1, 1980 with a rollover bar may be raced as is provided the mounting structure is acceptable.

Any vintage racing vehicle prepared after this time must be fitted with a roll cage complying with the Improved Production requirements as a minimum.

2. CONSTRUCTION MATERIALS

The main hoops and primary bracing should be constructed from round, mild steel, ERW or DOM type tubing.

Chrome-moly tubing such as 4130, may be used but is not recommended.

Chrome moly welding most often requires pre-heating, compatible filler wire to avoid brittleness in the welds, post-weld cooling and stress-relieving.

Aluminum and composite materials are prohibited construction materials for roll cage structures.

All cages must have a 0.476 cm (.1875") diameter inspection hole drilled in each main hoop.

Minimum tube size and wall thickness are as follows for vehicle weights including competitor:

Under 1500 lbs 3.49 cm X 0.24 cm (1.375" X .095")

Under 2500 lbs 3.81 cm X 0.24 cm (1.500" X .095") or 3.49 cm X 0.30 cm (1.375" X .120")

Over 2500 lbs 3.81 cm X 0.30 cm (1.500" X .120") or 4.44 cm X 0.24 cm (1.750" X .095")

3. FABRICATION

One continuous piece of tubing must be used for the main hoop. A similar piece shall be used for the other main hoop or hoops. The allowable cage configurations are:

A figure of each hoop configuration is provided to illustrate the acceptable basic configurations:

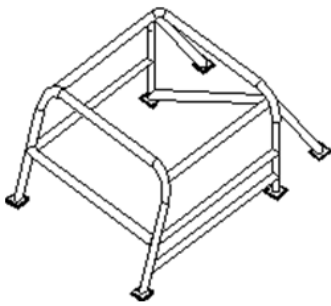

**Figure 1 Main Hoop
Parallel Front Hoop**

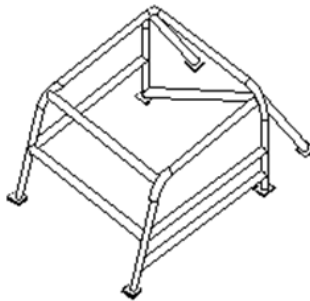

**Figure 2 Main Hoop
Two Side Hoops**

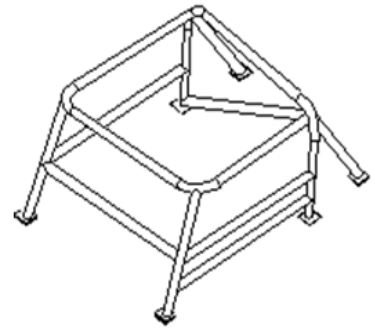

Figure 3 Main Hoop Top Hoop

All bends must be smooth with no excessive evidence of crimping or any evidence of wall fracturing. All bars should start as close as possible to the floor of the vehicle and come as close as possible to the sides of the vehicle for maximum competitor protection.

Construction guidelines for acceptable Ovality and Crimping:

Ovality:

Maximum allowable ovality is 8% of the nominal pipe diameter. Ovality is measured as the variation between the maximum and the minimum dimension of the pipe in one location per **Figure 1**.

Figure 1: Ovality

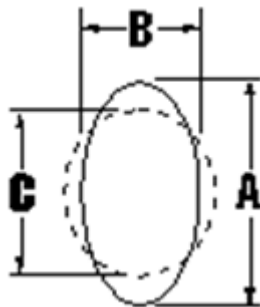

Formula for Ovality:

$$(A-B) / C = 0.08 \text{ Maximum}$$

Note:

A = Maximum Measurement

B = Minimum Measurement

C = Normal Diameter

Crimping: Crimping is measured per **Figure 2**. The maximum allowable crimping is 3% of the nominal pipe diameter.

Figure 2: Crimping

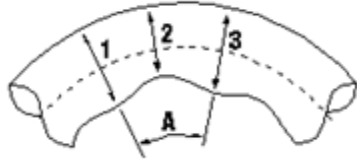

Formula for Crimping:

$$((OD_1 + OD_3) / 2) - OD_2 = 0.03 \text{ Maximum}$$

In the case of tube frame vehicles, the roll cage structure must be attached to the chassis with suitable webbing or gusseting to distribute loads over as wide an area as possible.

In the case of unit body vehicles, it is recommended procedure to attach the four ends of the main hoop tubes into L shaped plates at the junction of the floor and rocker panels rather than just to a plate on the floor. Additionally, it is highly recommended that all cages be tabbed into the basic body structure at least every 60.96 cm (24") or wherever possible.

4. BRACING

In the case of the twin lateral hoop design, the front and rear hoops shall be joined by a piece of equal dimensioned tubing on each side.

Rear stays must attach to the rear hoop no lower than 20.32 cm (8") from the top of the hoop and at an angle no steeper than 35 degrees from vertical. These rear stays must be made from a straight piece of tubing and be attached to a suitably stiff or reinforced area. A diagonal brace must be fitted from near the top of the hoop to a position near the opposite corner of the hoop. This brace must be as straight as possible.

Side protection bars must be attached between the front and rear hoops on both sides of the vehicle. These bars should be attached to the front hoop no higher than 30.48 cm (12") off the floor and on the rear hoop and no higher than 60.96 cm (24") off the floor. The competitor's side must be fitted with at least two side protection bars which follow as closely as possible the outline of the door. NASCAR style multiple anti-intrusion bars are highly recommended.

A bar joining the two outer members of the front hoop near steering column level is required.

5. MOUNTING PLATES

The four lower hoop tubes must be connected to plates welded or bolted to the frame or floor of the vehicle.

On unit body vehicles, all plates shall be at least 129 square cm (20 square") in area. The minimum thickness of these plates shall be 0.20 cm (.080") in the case of weld on plates and .1875 for bolt-on types. Bolt-on types shall have a minimum of three 0.952 cm (.375") grade 5 bolts fastening each plate and must have a backup plate of equal size and thickness on the other side of the floor with the bolts passing through both plates and the floor.

Vehicles with frame type construction must use plates of at least 51.6 cm square (8-in square) area and .1875 thickness regardless of whether they are bolted or welded.

6. WELDING

It is essential that all welding be of the highest possible quality. Slag welds, poor arc and gas welds are NOT acceptable. It is highly recommended that only certified people carry out arc welding on roll cages. TIG or MIG are the preferred welding processes. Cages with unacceptable welding will not be passed.

7. GUSSETING

It is important that loads be distributed over as wide an area as possible especially in the case of cages on space frame type vehicles. Gussets or tie-in tubes must be used at main tube junctions of the roll cage members. Gussets should also be used when it is not possible to weld all around a tube because of body interference. Gusset thickness should be at least the same as the tubing wall thickness they are attached to. Each gusset shall extend in length for a minimum of one pipe diameter in both directions from the centre point of the gusset.

8. REMOVABLE TYPE CAGES

Removable roll cages may be fitted to vehicles only if their construction and design allow them to meet the strength requirements of the designs above.

Where tubes join, a double shear type mating tab may be used. Where such a tab is used, the tube joining this tab shall have a small piece of tubing welded perpendicular to its length for the bolt to pass through to prevent crushing of the main tube.

Tabs shall be at least 3.49 cm (1.375") wide and 0.476 cm (.1875") thick and must be welded to one of the main tubes. When single bolts are use to fasten tubes, they must be of at least 1.11 cm (.4375") diameter and grade 8 material.

Sliding tube type junctions may also be used if they meet the following criteria:

- i. Wall thickness of the joining tube shall be a minimum of 0.30 cm (.120").
- ii. Length of this tube shall be a minimum of 7.62 cm (3") on either side of the splice.

Attachment shall be made using two bolts on each side of the splice 90 degrees to each other passing straight through the tubing. Grade 5 bolts of at least 9.52 cm (.375") diameter shall be used here. Splicing tubes may be slid either inside the main tubing or over the outside.

Alternate joint designs may be approved at the discretion of the Scrutineer.

Basic design and fabrication of removable type cages must conform to the specifications for non-removable type cages.

9. ALTERNATE DESIGNS

Alternate cage designs may be approved by the Scrutineer provided the competitor can produce stress analysis data from a certified engineer stating that the roll over structure is capable of withstanding the following loads applied simultaneously to that structure:

- 1.5 G lateral
- 5.5 G fore/aft
- 7.5 G vertical

Calculations shall assume the all up race weight of the vehicle with competitor.